

魔女の帽子①

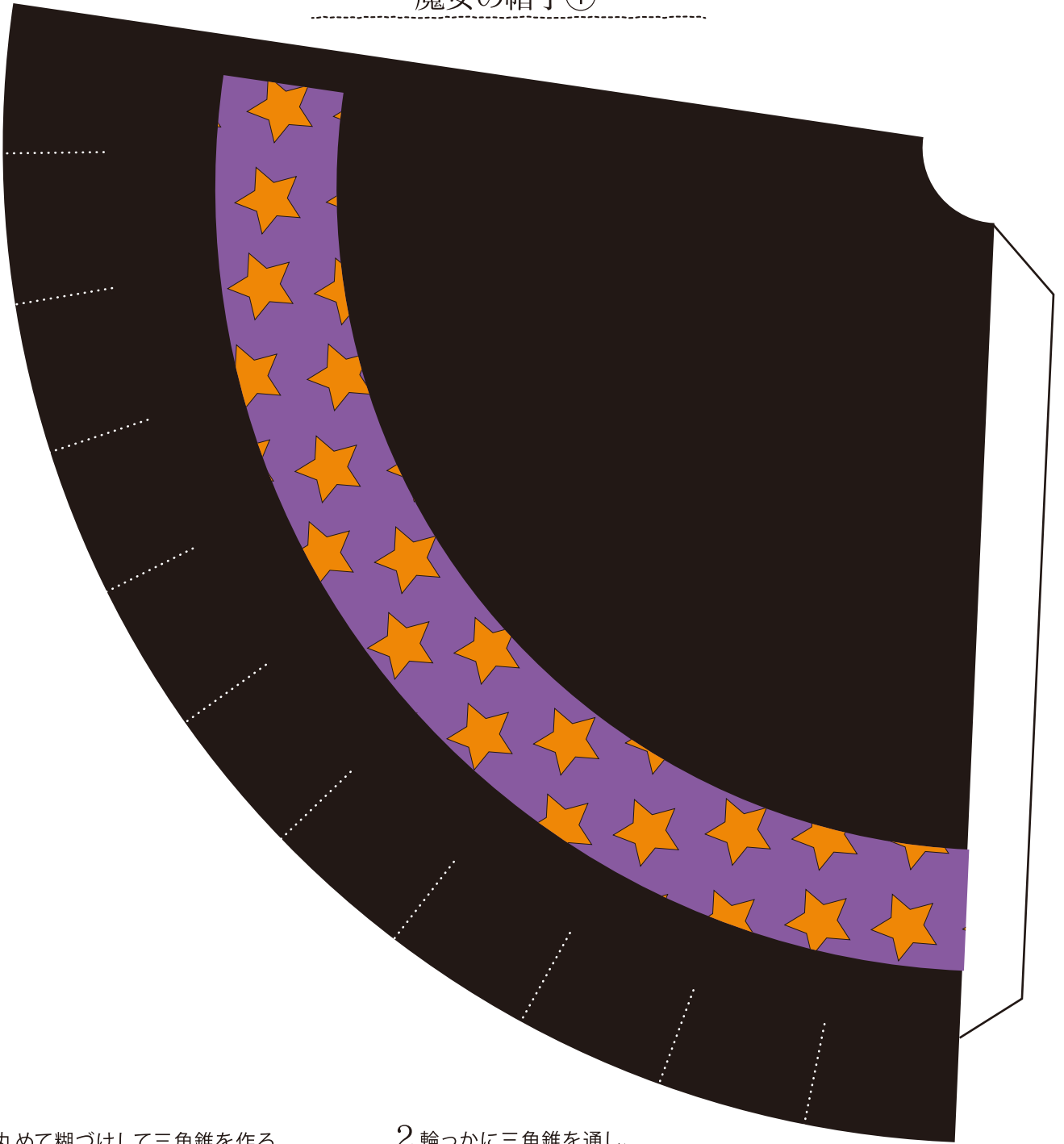

1 丸めて糊づけして三角錐を作る。
点線でカットして上向きに折り曲げる。

2 輪っかに三角錐を通し、
裏側をセロテープで留める。

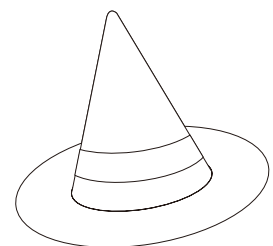
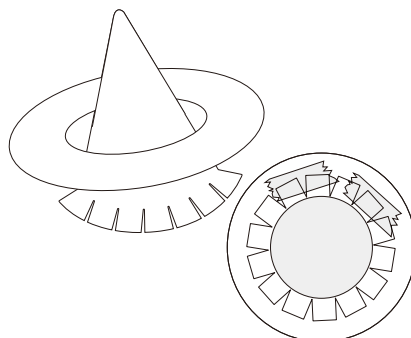
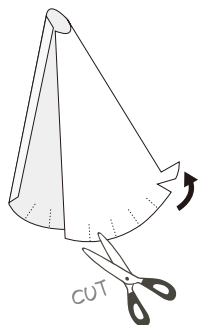

魔女の帽子②



1 丸めて糊づけして三角錐を作る。
点線でカットして上向きに折り曲げる。

2 輪っかに三角錐を通し、
裏側をセロテープで留める。

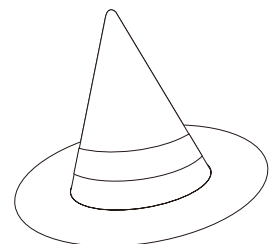
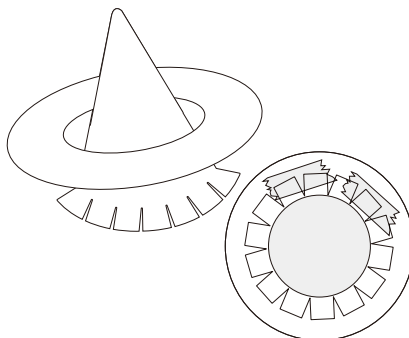
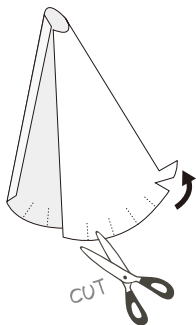

魔女の帽子③

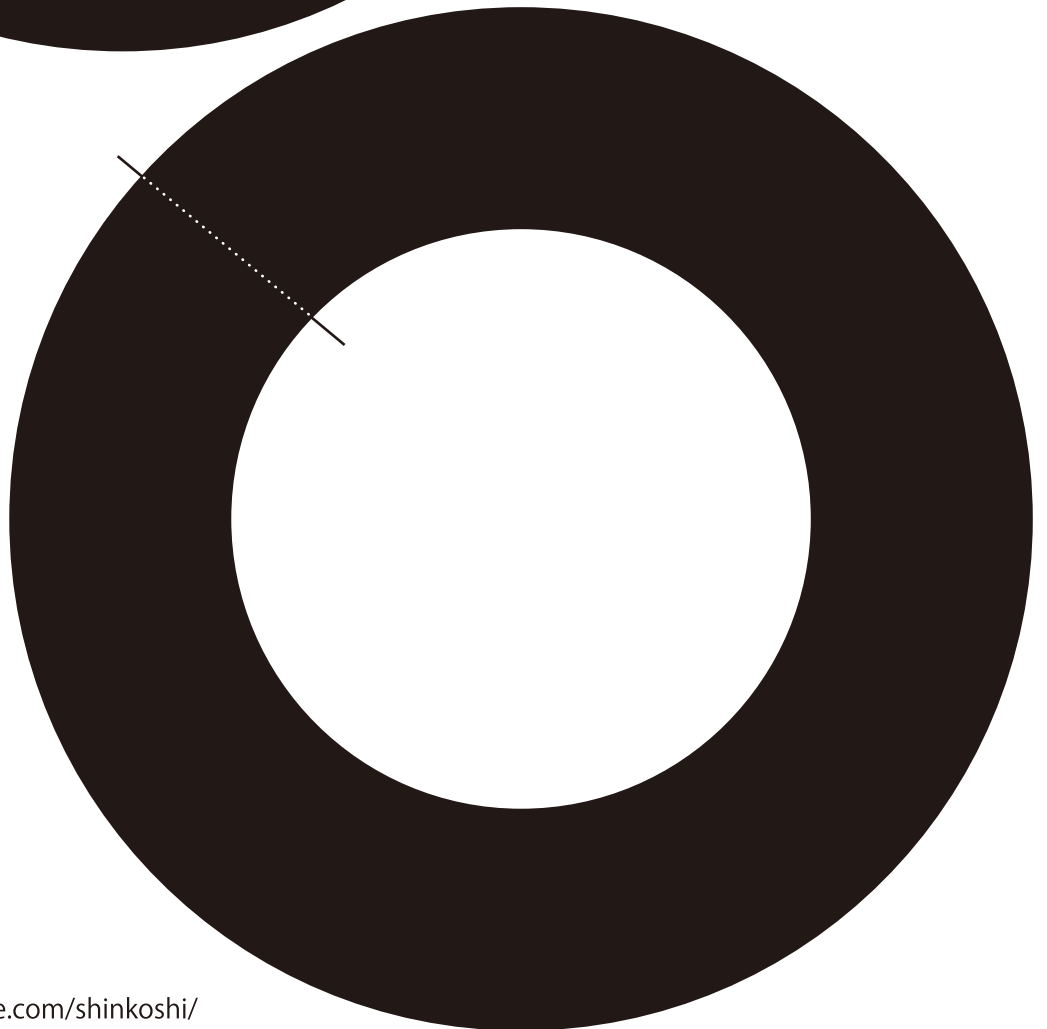
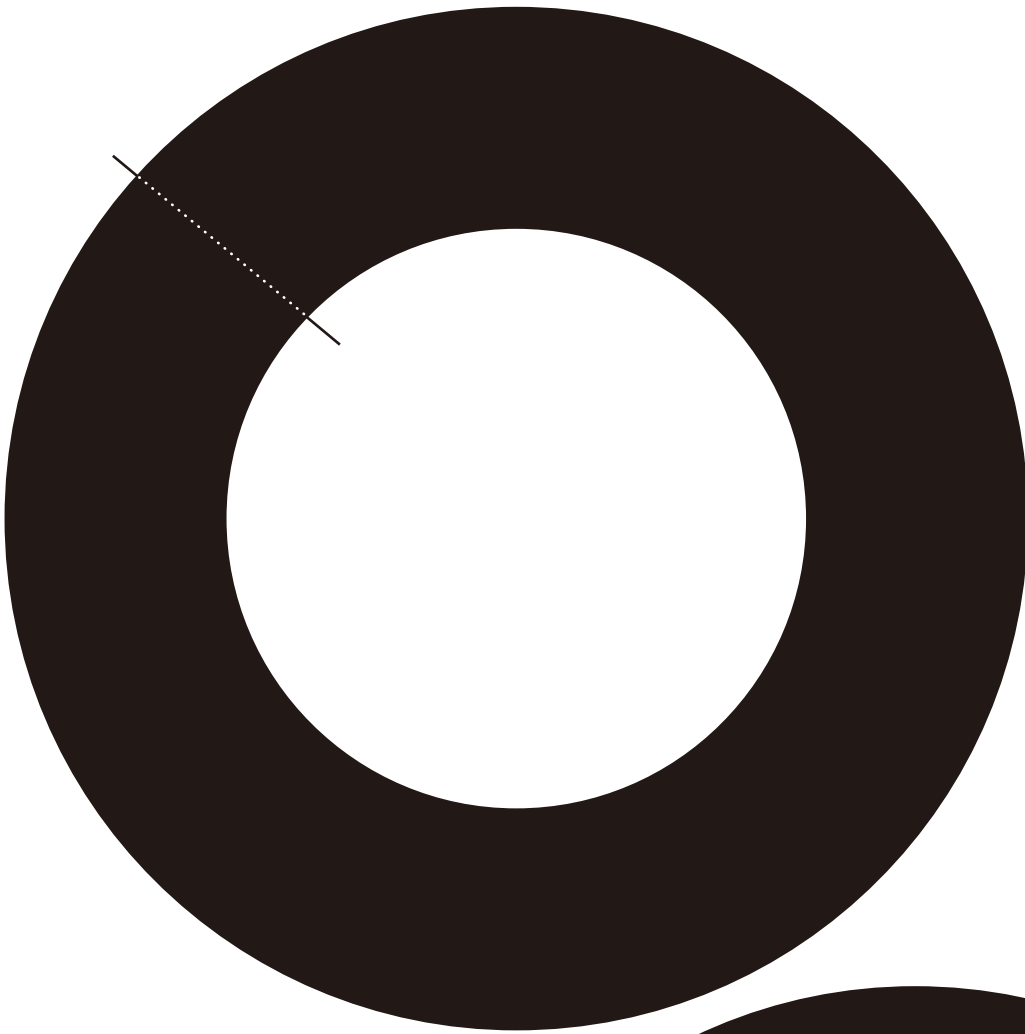

ガーランド①

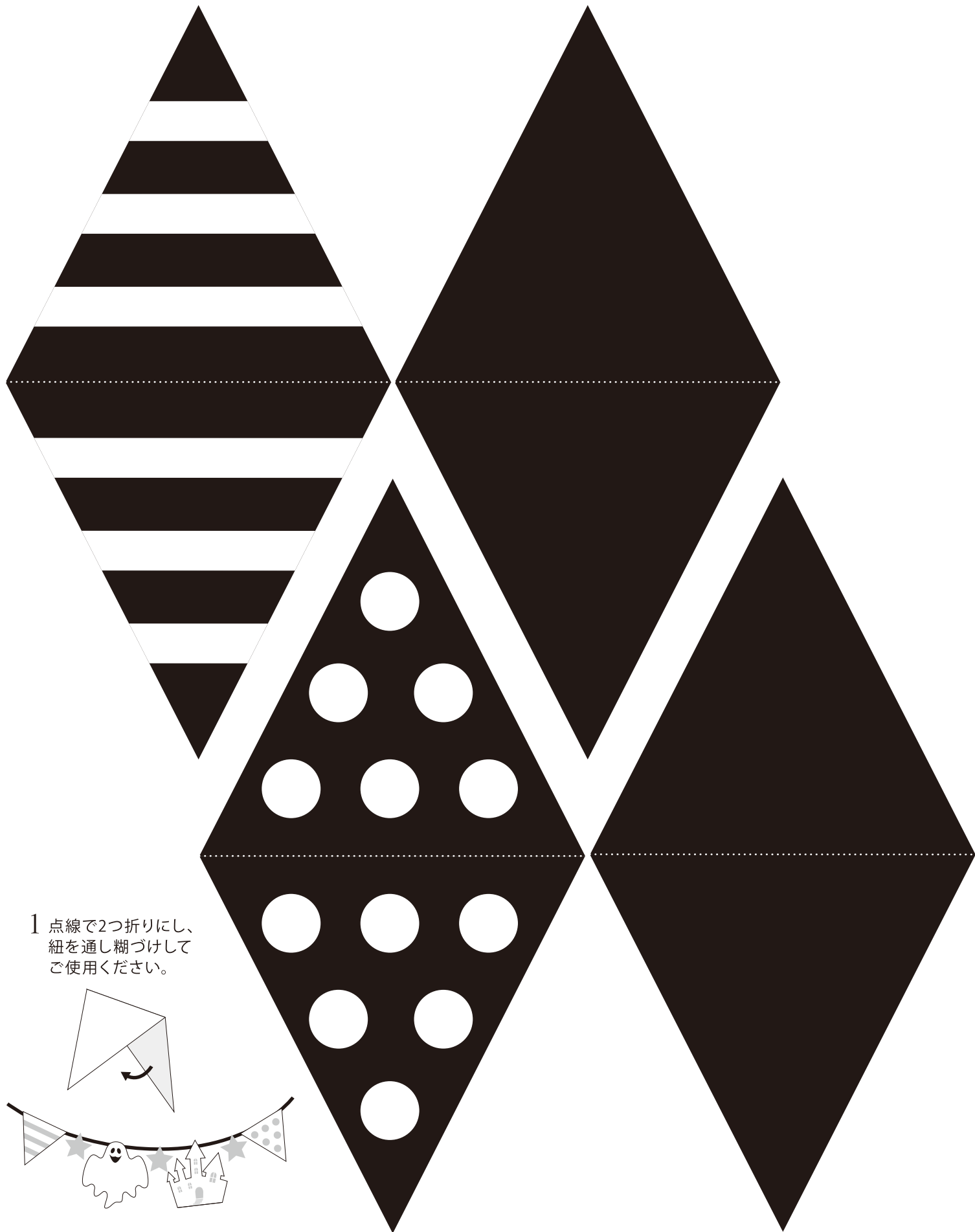

1 点線で2つ折りにし、
紐を通し糊づけして
ご使用ください。

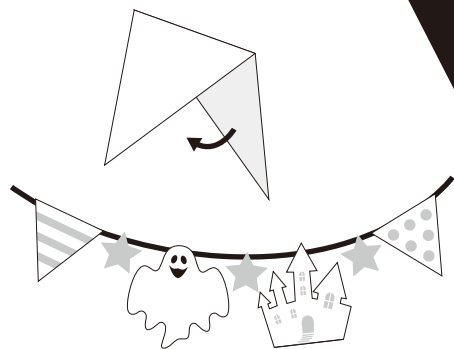

ガーランド②

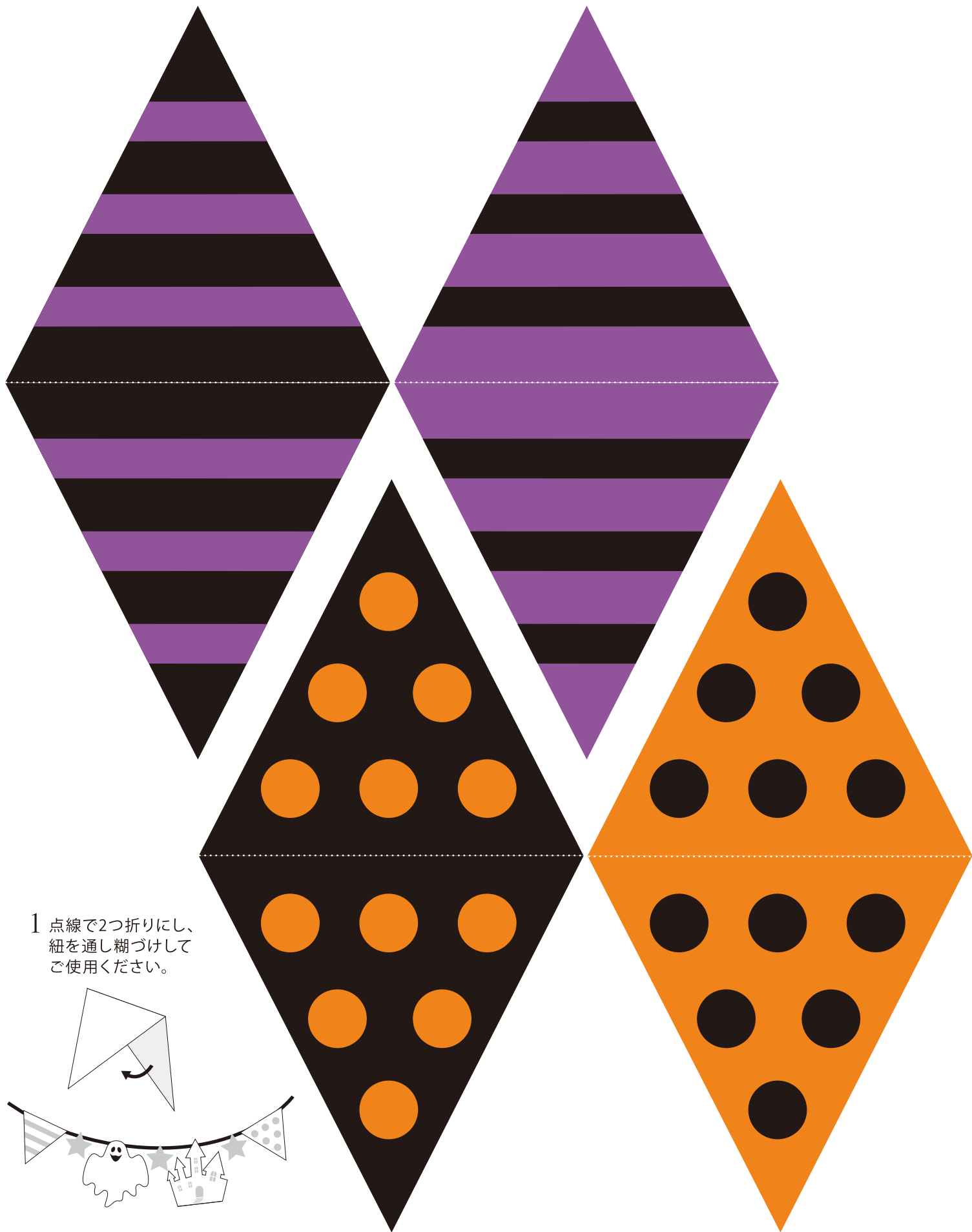

ガーランド③

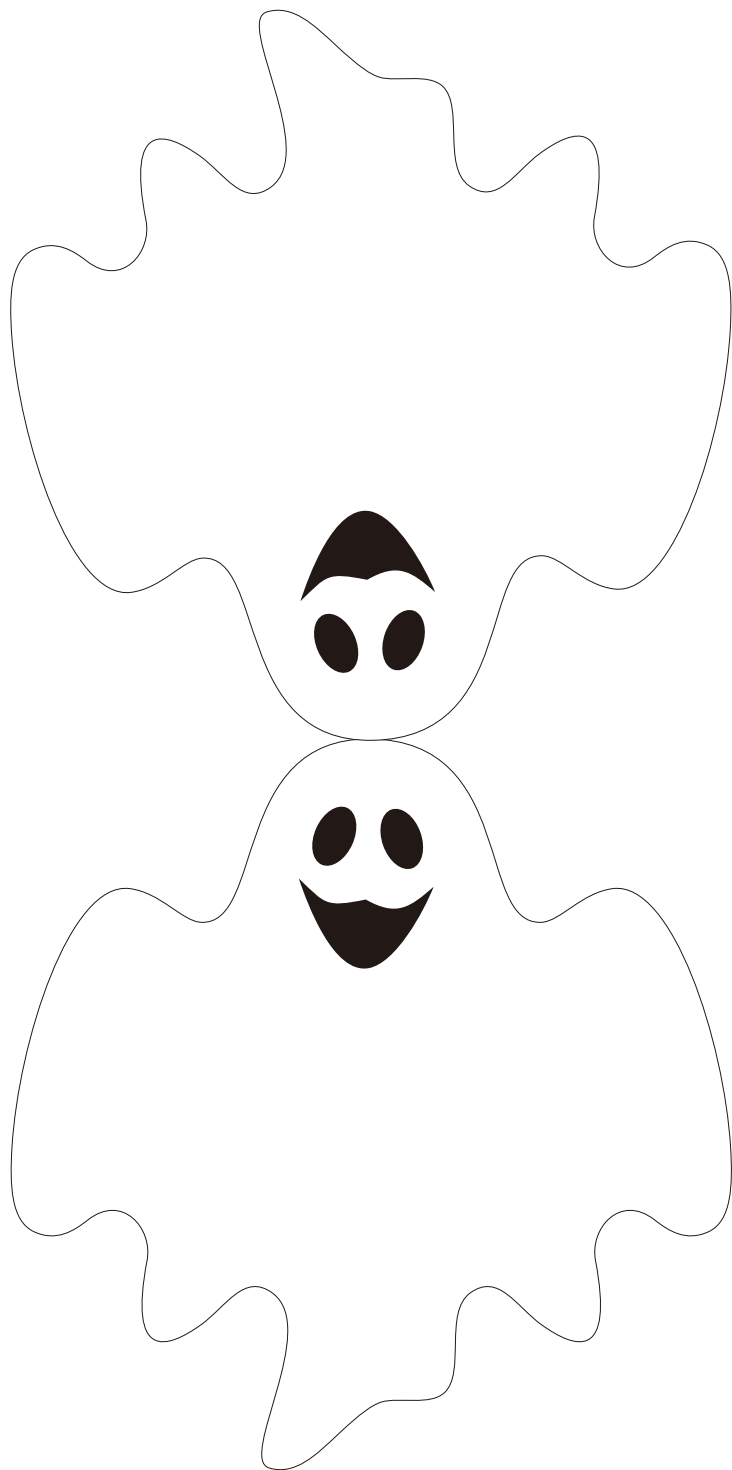
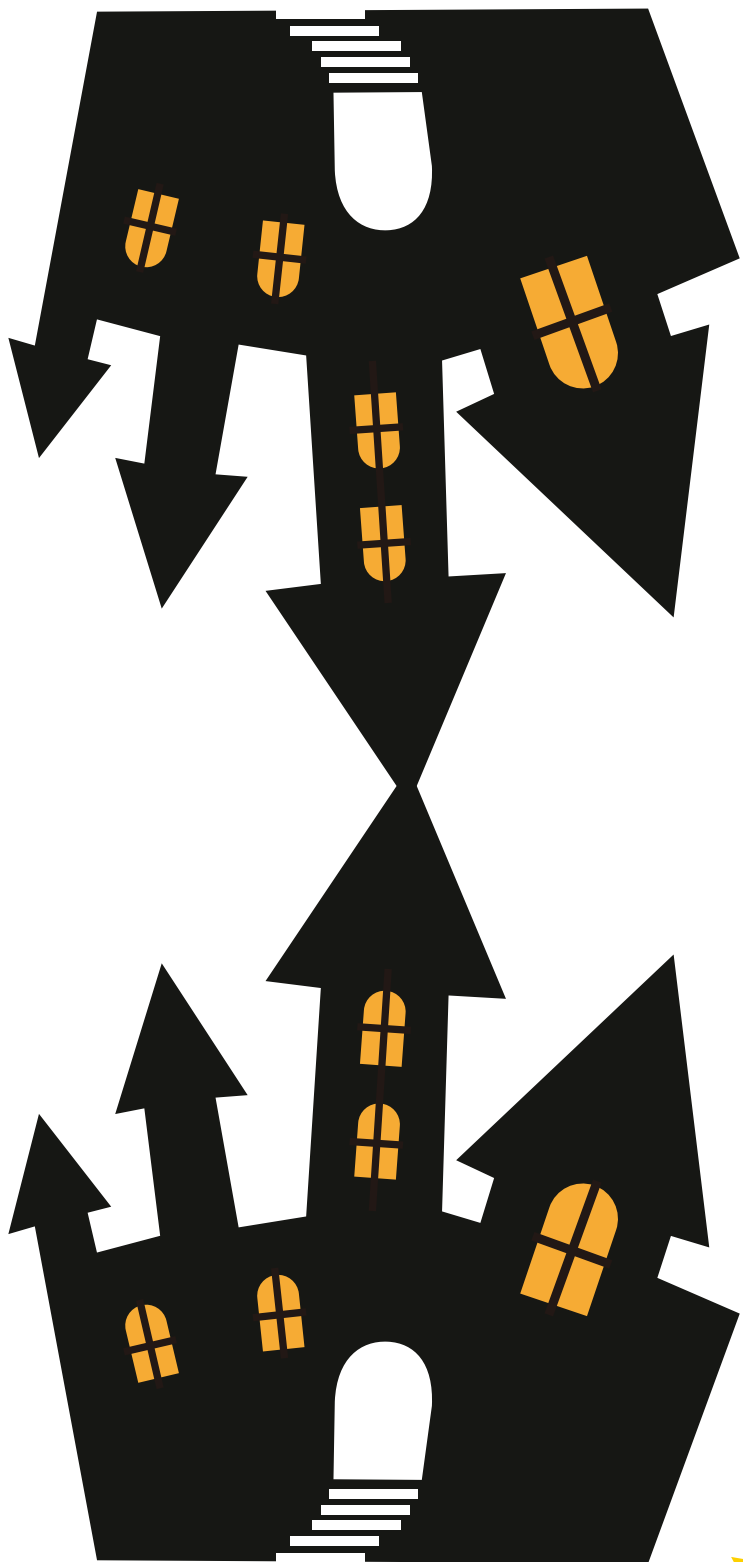

ガーランド④



ガーランド⑤

